

CANopen Slave/DCON Master Gateway

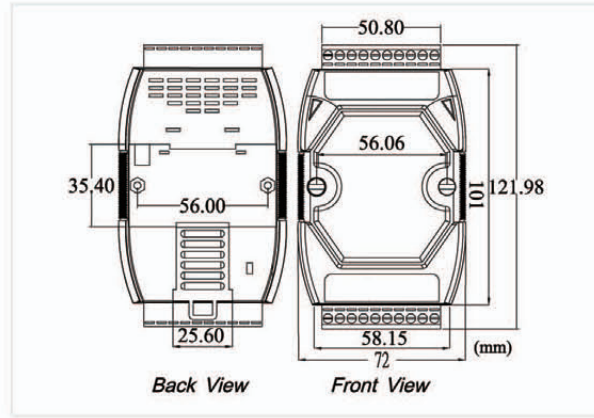

I-7231D



The I-7231D is specially designed for the slave device of CANopen protocol. It follows the CANopen Spec DS-301 V4.02 and DSP-401 V2.1, and supplies many features for users, such as dynamic PDO, EMCY object, error output value, SYNC cyclic and acyclic ... etc. The I-7231D supports up to 15 DCON modules for I/O expansion and suits with a lot of ICP DAS DI/AI/DO/AO modules. User can choose DI/DO/AI/AO modules of I-7K/I-87K series to fit the customized practice applications. In addition, we also provide I-7231D Utility to allow users to create the EDS file dynamically.

Features

- NMT: Slave
- Error Control: Node Guarding and Heartbeat Producer protocol
- No. of SDOs: 1 Server, 0 Client
- No. of PDOs: default 4 TxPDO and RxPDO
- PDO Modes: Event Triggered, Remotely requested, Cyclic and Acyclic SYNC
- Emergency Message: available
- CANopen Version: DS-301 v4.02
- Device Profile: DSP-401 v2.1
- Produce EDS file Dynamically
- Run, ERR, and Overrun indicator
- Support Max 15 I-7K/I-87K series modules
- CAN Baud Rate setting by utility: 10K, 20K, 50K, 125K, 250K, 500K, 800K, 1M bps
- 7-segment LED to show Node ID, CAN baud rate and RS-485 baud rate

Design Flowchart

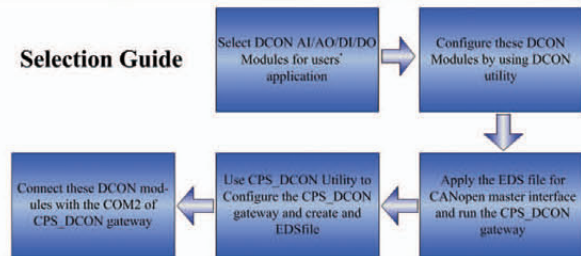

Utility Features

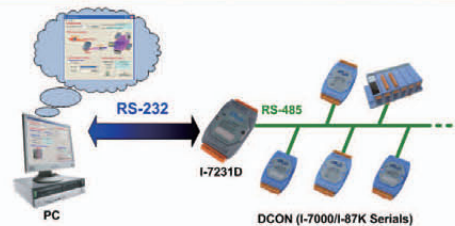

I-7231D main unit can connect to the DCON(I-7K/I-87K) IO modules to create a customized CANopen slave device and application. In order to allow user to easy apply the device on the network, ICP DAS also provides the I-7231D Utility tool to configure the IO connection path, assembly and application objects information and create the EDS file of the device.

Configuration by Utility

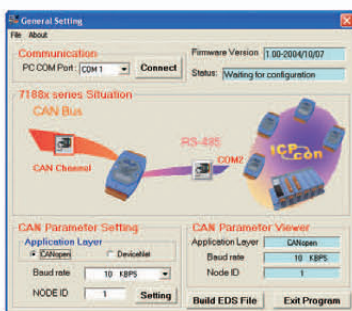

Pin Assignments

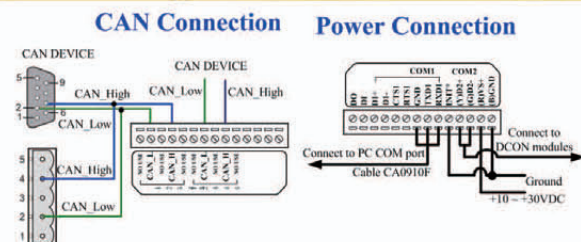

Hardware Specifications

Hardware	
CPU	80188, 40 MHz or compatible
SRAM/Flash/EEPROM	512 KB / 512 KB / 16 KB
Watchdog	Watchdog IC
CAN Interface	
Controller	NXP SJA1000T with 16 MHz clock
Transceiver	NXP 82C250
Connector	5-pin screwed terminal block (CAN_L, CAN_H, N/A for others)
Isolation	1000 V _{DC} for DC-to-DC, 2500 V _{rms} for photo-couple
Terminator Resistor	Jumper for 120 Ω terminator resistor
Protocol	CANopen DS-301 ver4.02, DS-401 ver2.1
UART Interface	
COM 1	RS-232 (For configuration)
COM 2	RS-485 (Self-turner inside)
Transmission Distance (m)	Depend on baud rate (for example, max. 1200 m at 9.6 kbps)
Baud Rate (bps)	1200, 2400, 4800, 9600, 19200, 38400, 57600, 115200
Protocol	DCON
LED	
Round LED	MS LED, NS LED, IO LED
5-digit 7 Segment	Yes
Power	
Power supply	Unregulated +10 ~ +30 V _{DC}
Protection	Power reverse polarity protection, Over-voltage brown-out protection
Power Consumption	3W
Mechanism	
Dimensions	72mm x 122mm x 33mm (W x L x H)
Environment	
Operating Temp.	-25 ~ 75 °C
Storage Temp.	-30 ~ 80 °C
Humidity	10 ~ 90% RH, non-condensing

Application

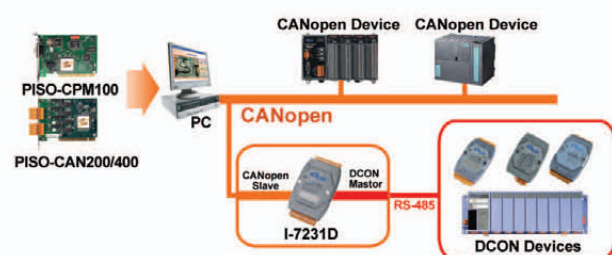

5-digit 7-Segment LED Display

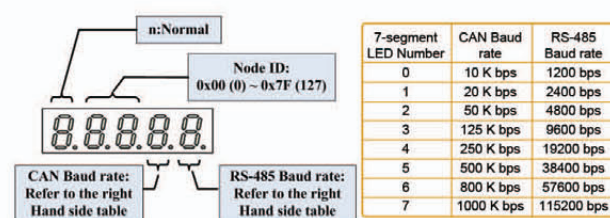

LED indicators

LED	Description
RUN	Indicates the status of the physical layer
ERR	Indicates the condition of the CANopen network state mechanism
OVERRUN	Indicates CAN message loading is heavy and cause buffer overrun

Ordering Information

I-7231D-G	CANopen Slave/DCON Master Gateway
I-7231D-G CR	CANopen Slave/DCON Master Gateway (RoHS)